



超硬品质 全心服务
Super Quality Dedicated Service



上海山田刀具有限公司

地址: 上海市青浦区练塘工业园区章练塘路265号
电话: 021-69208966
传真: 021-69209362 69209361
邮箱: sales@yamadachina.com
网址: //www.yamadachina.com
服务热线: 400-968-8966

Shanghai Yamada Tools CO., LTD

Address: NO.265 ZhanglianTang Road, Qingpu District, Shanghai, China
Tel: +8621-69208966
Fax: +8621-69209362 69209361
Email: sales@yamadachina.com
Http: //www.yamadachina.com
Hotline: 400-968-8966



扫描二维码
添加关注, 了解更多信息。

CBN切削刀片
CBN CUTTING INSERT

超硬加工解决方案
superhard machining solutions

山田CBN系列 Yamada CBN series

我们的优势:

山田公司和国际优秀材料供应商战略合作，针对性开发了高效率CBN切削用材料。CBN材料的硬度仅次于PCD，并且与铁系金属亲和性低，即使在高温（1000°C）状态下仍然能够保持原有的强度和硬度，并且不会和铁、镍、钴等金属发生化学反应。在加工淬硬钢、粉末冶金、铸铁等难切削材料时实现了高效率 and 长寿命！合理的设计理念、全自动化批量生产模式使产品能够拥有更稳定的品质并最大限度的发挥出 CBN 材质的优异性能！

Our advantages:

Shanghai Yamada Tools Co.,Ltd. builds a strategic cooperation with foreign material suppliers, specifically developing high-efficiency CBN cutting material.CBN material hardness is next to PCD,and the affinity with iron metal is low, it can still keep original strength and hardness even though under high temperature (1000°C), won't react chemically with iron,Ni,Co or other metals.The high-efficiency and long-life will come true while processing hardened steel,powdering metallurgy,casting iron and difficult-cut materials! Rational design philosophy and fully automated mass production mode will make the production stable and the CBN material excellent to the furthest.

加工材质 work material	是否涂层 coated or not	山田CBN YAMADA CBN grade	加工形态 process form	我们的优势 our advantage
淬硬钢 hardened steel	涂层 coated	BTC10	高速连续加工 high-speed continuous machining	PVD 涂层材质，结合耐月牙洼磨损的 CBN 母材和特殊高耐磨性的 PVD 涂层，所以特别适合在连续车削条件下对淬硬钢进行高速精加工。 PVD coated material is especially suitable for high-speed finishing of hardened steel in continuous turning, thanks to crater wear resistance CBN base material and special high wear resistance PVD coating.
		BTC20	通用型 general type	PVD 涂层材质，选用耐磨性和高韧性的 CBN 母材，并附加高耐磨性的涂层，所以特别适合在连续切削至中等断续切削条件下对淬硬钢进行精加工。对淬硬钢的切削有较高的通用性。 PVD coated material is especially suitable for finishing of hardened steel in continuous cutting to medium interrupted cutting,and more universal to cutting for hardened steel, thanks to using wear resistance and high toughness CBN base material and high wear coating.
		BTC30	断续 - 重断续加工 interrupted-heavy interrupted machining	PVD 涂层材质，选用具有优异耐磨性的 CBN 母材和耐剥落性的 PVD 涂层，特别适合于在重断续切削条件下对淬硬钢进行精加工，尤其适合纯粹的断续切削。 PVD coated material is especially suitable for finishing of hardened steel in heavy interrupted cutting,specific for interrupted cutting,thanks to using excellent breakage resistance CBN base material and peel resistance PVD coating.
	无涂层 uncoated	BT100	连续加工 continuous machining	低含量的 CBN 材质，主要强调抗月牙洼磨损性能，用于在连续切削条件下对淬硬钢进行高速精加工。 Low content of CBN material,mainly emphasized on crater wear performance,used for high-speed finishing of hardened steel in continuous cutting.
		BT110	连续 - 轻断续 continuous-light interrupted	低含量的 CBN 材质，有较高的耐磨性，用于在连续切削至轻微断续切削条件下对淬硬钢进行中速精加工。 Low content of CBN material,with high wear resistance,used for medium-speed finishing of hardened steel in continuous cutting to light interrupted cutting.
		BT120	连续 - 中断续 continuous-midium interrupted	中等含量的 CBN 材质，在耐磨性和抗冲击韧性间高度均衡，用于在连续切削至中断续切削条件下对淬硬钢进行精加工。具有较高的通用性。 Middle content of CBN material,high equal in wear resistance and impact toughness resistance,used for finishing of hardened steel in continuous cutting to medium interrupted cutting,has high general purpose.
		BT130	连续 - 重断续 continuous-heavy interrupted	高含量的 CBN 材质，有较高的抗冲击韧性，用于在连续切削至重断续切削条件下对淬硬钢进行精加工。 High content of CBN material,has high impact toughness resistance,used for finishing of hardened steel in continuous cutting to heavy interrupted cutting.

加工材质 work material	是否涂层 coated or not	山田CBN YAMADA CBN grade	加工形态 process form	我们的优势 our advantage
淬硬钢 hardened steel	无涂层 uncoated	BT135	纯粹的重断续 heavy interrupted	高含量的 CBN 材质，具有非常高的强韧性和抗冲击韧性，主要针对淬硬钢纯粹的重断续切削而开发。 High content of CBN material,with strong toughness and impact roughness resistance,aimed at developing for heavy interrupted cutting of hardened steel.
铸铁 cast iron	无涂层 uncoated	BT310	连续 - 断续 continuous-interrupted	高含量的 CBN 材质，铸铁加工的通用材料。 High content of CBN, is general material for machining cast iron.
		BT320	连续 - 断续 continuous-interrupted	高含量的 CBN 材质，具有较高的耐磨性和卓越的冲击强度，适用于连续切削至间断切削条件下切削高硬度铸铁和球墨铸铁。 High content of CBN material has high wear resistance and outstanding impact resistance,suitable for high hardness cast iron and nodular cast iron in continuous cutting to interrupted cutting.
		BT330	连续 - 断续 continuous-interrupted	高含量的 CBN 材质，具有较高的耐磨性和卓越的冲击强度，适用于连续切削至间断切削条件下切削珠光体灰口铸铁。 High content CBN material,has high wear resistance and outstanding impact resistance strength,suitable for cutting pearlitic grey cast iron in continuous cutting to interrupted cutting.
高温合金 / 烧结金属 high temperature alloy /sintering metal	无涂层 uncoated	BT510	连续 - 轻断续 continuous-light interrupted	中等含量的 CBN 材质，具有良好的化学稳定性和耐磨性，适用于连续切削至轻微断续切削条件下对高温合金和烧结金属进行加工，尤其适合进排气阀座的加工。 Middle content of CBN material,with excellent chemical stability and wear resistance,suitable for machining high temperature alloy and sintering metal in continuous cutting and light interrupted cutting,especially suitable for machining intake and exhaust valve seat.
		BT520	连续 - 断续 continuous-interrupted	高含量的 CBN 材质，有较高的耐磨性和韧性，适用于连续切削到中等断续切削条件下对高温合金和烧结金属进行加工。 High content of CBN material,with high wear resistance and toughness,suitable for machining high temperature alloy and sintering metal in continuous cutting to middle interrupted cutting.

标准CBN刀片编号规则 Standard CBN insert numbering rule

2 XX - C N G A 12 04 08 SH S 012 25

① ② ③ ④ ⑤

① 切削刃记号 cutting edge mark	
记号 (mark)	切刃数 (no. of cutting edges)
无 (none)	1 个切刃 (1 cutting edges)
2	2 个切刃 (2 cutting edges)
4	4 个切刃 (4 cutting edges)
6	6 个切刃 (6 cutting edges)
8	8 个切刃 (8 cutting edges)

② 涂层记号 coating mark	
记号 (mark)	意义 (mean)
MC	涂层 (coated)
MU	无涂层 (uncoated)

③ ISO 标准代号
standard code

④ 特殊刃口处理 special edge treatment		
记号 (mark)	意义 (mean)	倒棱尺寸 (chamfer size)
SH	锋利型 sharp type	0.1*15°
无 (none)	通用加工 general machining	0.12*25°
ST	强化刃口 strengthen the edge	0.17*30°
FU	全面 CBN full face CBN	
TR	粗加工断屑槽 rough machining chipbreaker	
TF	精加工断屑槽 finish machining chipbreaker	
W	带修光刃 with wiper cutting edge	

⑤ 刀尖样式 tool nose type	
记号 (mark)	意义 (mean)
F	锋利刀尖 sharp tool nose
E	仅珩磨 R just honing R-angle
T	仅倒棱 just chamfer
S	倒棱 + 珩磨 chamfer+honing

备注 :S01225 表示:倒棱角度为 25°, 宽度为 0.12mm, 有 R 钝圆
remark:S01225 means the chamfer angle 25°, l and width 0.12mm,with R blunt round

淬火钢切削涂层CBN系列

CBN coating series for cutting hardened steel

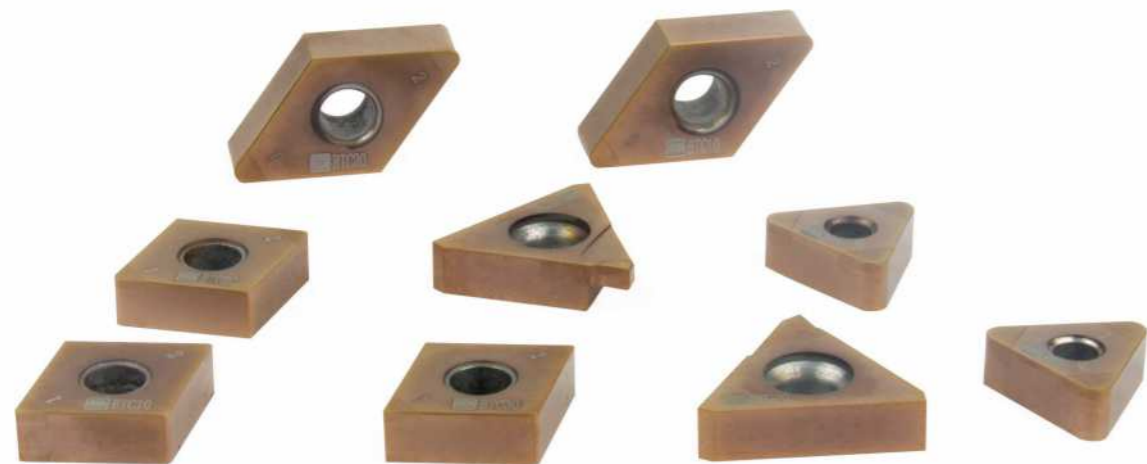

◆ 特点:

随着以车代磨技术的日益普及, 客户对切削速度和刀具寿命的要求也越来越高, 山田刀具开发了具有高韧性的 CBN 母材和优异耐磨性的涂层工艺, 实现了淬火钢加工的全新产品系列 CBN 涂层刀片, 由于取得更高的切削效率和刀具寿命, 所以可以有效地降低淬火钢的切削成本!

◆ Feature:

With the growing popularity of turning instead of grinding technology, customers have higher requirement of cutting speed and tool life. Yamada develops high toughness CBN base material and excellent wear resistance coated craft, realizing new CBN coated insert series for machining hardened steel, reducing cutting cost of hardened steel as achieving higher cutting efficiency and tool life.

淬火钢加工推荐切削条件

recommended cutting condition for machining hardened steel

材质 material	切削速度 cutting speed Vc(m/min)						进给 feed rate f (mm/rev)	切深 depth of cut ap (mm)
	50	100	150	200	250	300		
BTC10				180-220-300			0.03-0.08-0.15	0.05-0.12-0.2
BTC20		80-140-200					0.05-0.15-0.3	0.1-0.3-0.5
BTC30		80-140-180					0.05-0.1-0.2	0.05-0.2-0.4

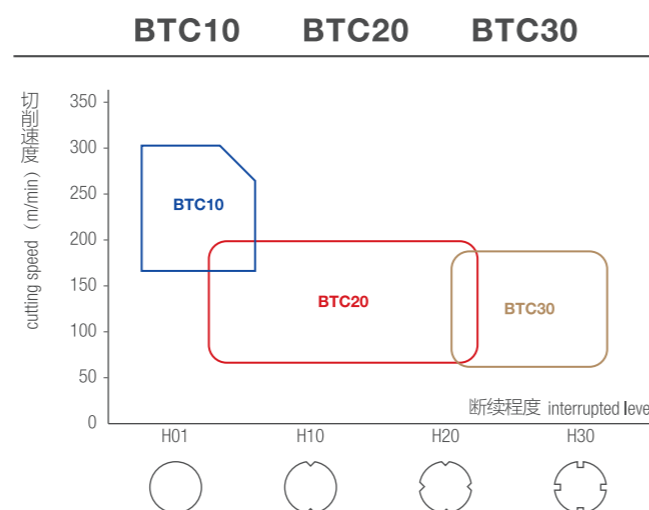

加工实例

Process instance

BTC10 高速连续切削 BTC10 high-speed continuous cutting

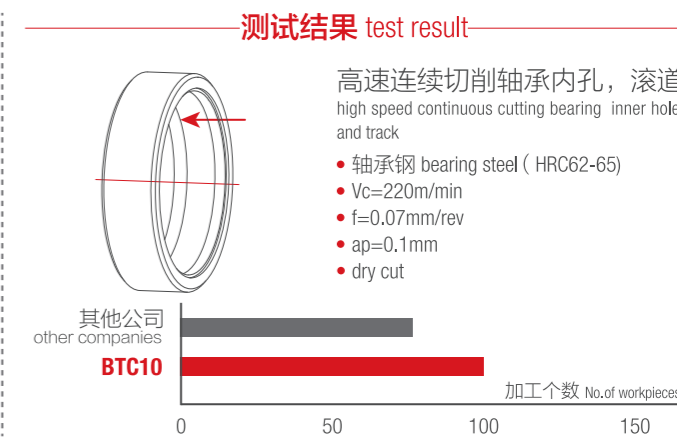
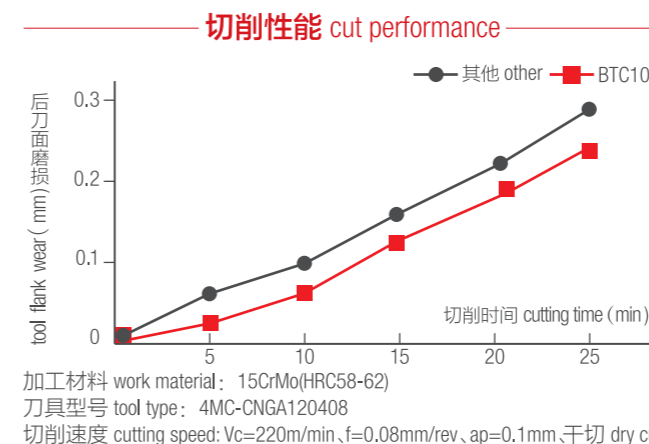

BTC20 通用加工 BTC20 general machining

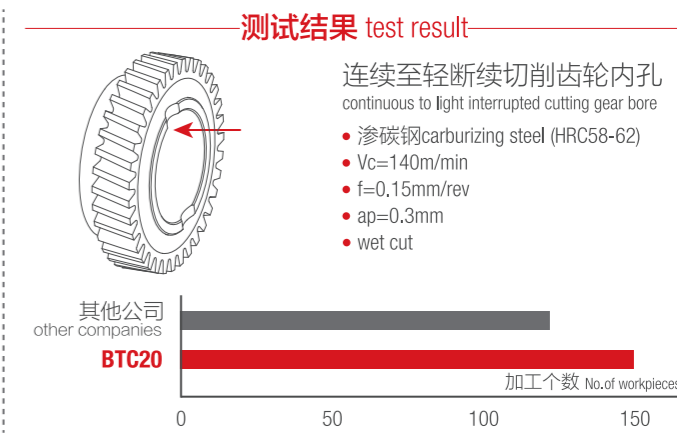
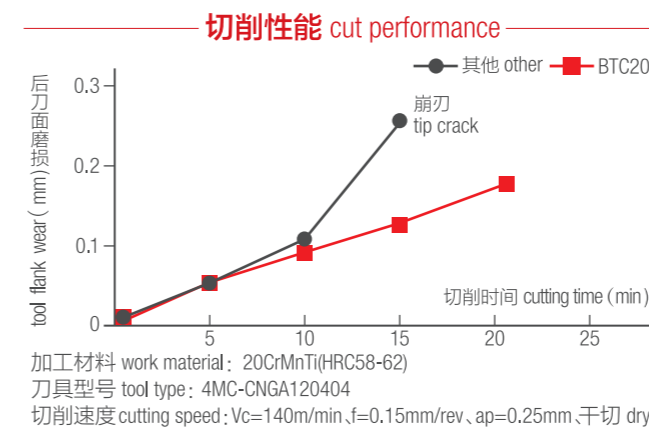

BTC30 重断续切削 BTC30 heavy interrupted cutting

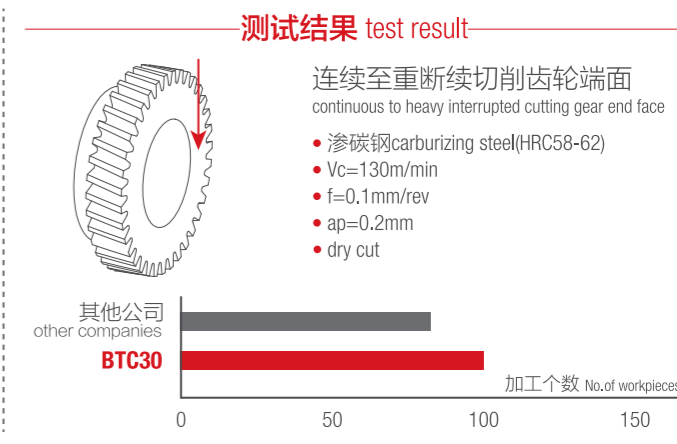
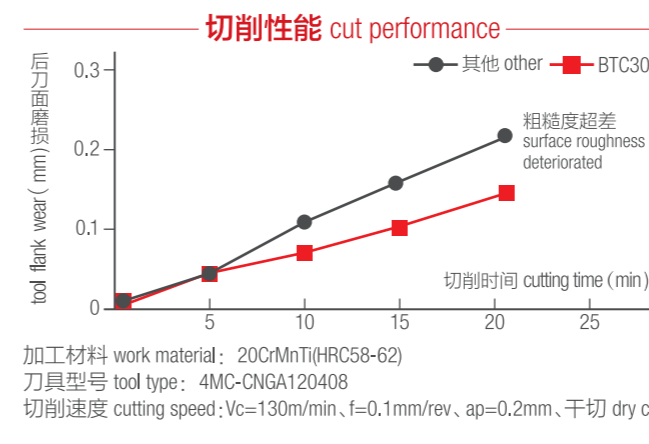

淬火钢切削CBN系列

CBN series for cutting hardened steel



◆ 特点:

山田非涂层 CBN, 采用不同粒径的 CBN 微粒和最新技术的结合剂, 兼具优异的耐崩损性和耐磨性, 从淬火钢的高速连续加工到严重断续加工均有不同的材质相对应, 配合山田优化的焊接和刃磨工艺, 更是将 CBN 的优势发挥的淋漓尽致, 并保证较高稳定性!

◆ Feature:

Yamada uncoated CBN, adopts different diameters of CBN particles and newly developed binder, with excellent breakage and wear resistance, has different corresponding materials from high speed continuous machining to heavy interrupted machining of hardened steel, and Yamada optimizing welding and grinding craft, makes CBN merit to an extreme and keep high stability.

BT100 BT110 BT120 BT130 BT135

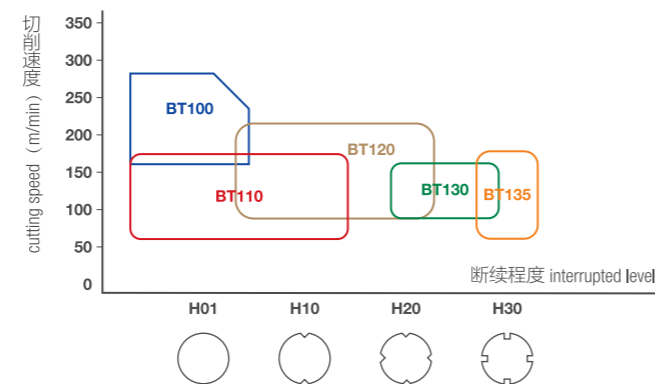

淬火钢加工推荐切削条件

Recommended cutting conditions for processing hardened steel

材质 material	切削速度 cutting speed Vc(m/min)					进给 feed rate f (mm/rev)	切深 depth of cut ap (mm)
	50	100	150	200	250		
BT100				170-220-280		0.03-0.08-0.15	0.05-0.12-0.2
BT110		100-130-180				0.05-0.15-0.3	0.1-0.3-0.5
BT120			150-180-220			0.05-0.1-0.2	0.05-0.2-0.3
BT130		80-130-150				0.05-0.1-0.35	0.05-0.2-0.4
BT135		80-130-180				0.05-0.1-0.35	0.05-0.2-0.3

加工实例

Process instance

BT100 高速连续切削

high speed continuous cutting

高速连续切削轴外径
high speed continuous cutting shaft external diameter

- 淬硬钢hardened steel (HRC58-65)
- 4MU-DNGA150408
- Vc=250m/min
- f=0.08mm/rev
- ap=0.1mm
- dry cut

其他公司 other companies

加工距离 (km) machining distance(km)

BT110 连续-轻断续切削

continuous-light interrupted cutting

连续切削外星轮外径
continuous cutting besides-star wheel external diameter

- 淬硬钢hardened steel (HRC58-62)
- 4MU-CNGA120408
- Vc=150m/min
- f=0.15mm/rev
- ap=0.3mm
- dry cut

其他公司 other companies

加工数量 (pcs) No. of workpieces (pcs)

BT120 连续-中断续切削

continuous-medium interrupted cutting

凸轮刮面、精车内孔
cam facing, finish turning internal hole

- 100Cr6
- TPGN160308 FU
- Vc=170m/min
- f=0.18/0.05mm/rev
- ap=0.3mm
- dry cut

其他公司 other companies

加工数量 (pcs) No. of workpieces (pcs)

崩刃 tip breakage
后刀面磨损 tool flank wear

BT130 连续-重断续切削

continuous-heavy interrupted cutting

花键割槽
Spline cutting groove

- UC1 (HRC58-62)
- Vc=110m/min
- f=0.04mm/rev
- ae=2.25mm
- dry cut

其他公司 other companies

加工数量 (pcs) No. of workpieces (pcs)

崩刃 tip breakage
后刀面磨损 tool flank wear

BT135 纯粹的重断续切削

heavy interrupted cutting

重断续切削内星轮外径
heavy interrupted cutting internal star wheel external diameter

- 20MnCr5 (HRC58-62)
- 3MU-TNGA160416
- Vc=170m/min
- f=0.08mm/rev
- ap=0.3mm
- dry cut

其他公司 other companies

加工数量 (pcs) No. of workpieces (pcs)

崩刃 tip breakage
后刀面磨损 tool flank wear

铸铁切削CBN系列

CBN series for cutting cast iron



◆ 特点:

山田非涂层 CBN 铸铁切削系列, 选用高含量的 CBN 材质, 具有较高的耐磨性和抗月牙洼磨损能力。并且高含量的 CBN 具有较高的热传导率和韧性, 能够胜任灰铸铁和冷硬铸铁的高速粗精加工!

◆ Feature:

Yamada uncoated CBN series for cutting cast iron, adopts high content of CBN material, with high wear resistance and crater wear resistance. High content of CBN has high thermal conductivity and toughness, realizing high speed rough and finish machining for gray cast iron and chilled cast iron.

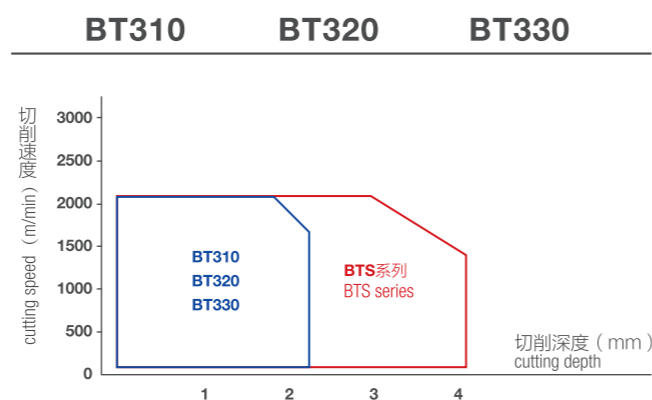

加工推荐切削条件

recommended cutting conditions

材质 material	切削速度 cutting speed Vc(m/min)						进给 feed rate f (mm/rev)	切深 depth of cut ap (mm)
	100	500	1000	1500	2000	3000		
BT310	200-800-2000						0.1-0.2-0.5	0.1-0.5-2.0
BT320	80-250-500						0.05-0.15-0.4	0.1-0.3-0.5
BT330	200-600-1000						0.08-0.15-0.4	0.1-0.3-0.5

加工实例

Process instance

BT310 连续 - 断续 continuous-interrupted

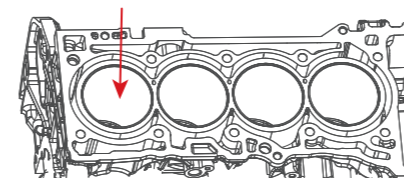

精镗缸孔

finish boring cylinder hole

- 加工材质 work material: HT250
- 刀片型号 insert type: HDGN050304
- Vc=800m/min
- fz=0.12mm/rev
- ap=0.75mm
- wet cut

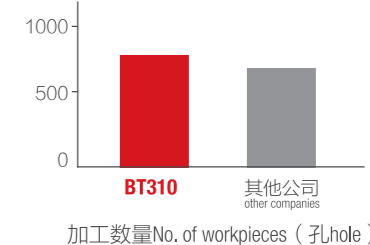

BT320 连续 - 断续 continuous-interrupted

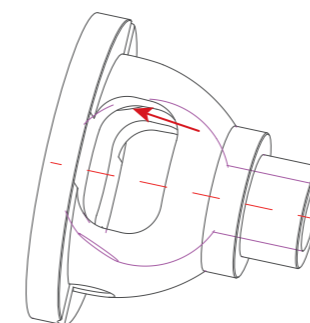

精车差速器壳体内球面

finish turning differential mechanism housing inner sphere

- 加工材质 work material: QT600
- 刀片型号 insert type: 4MU-DNGA150412
- Vc=300m/min
- f=0.2mm/rev
- ap=0.3mm
- dry cut

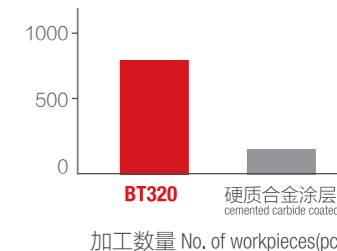

BT330 连续 - 断续 continuous-interrupted

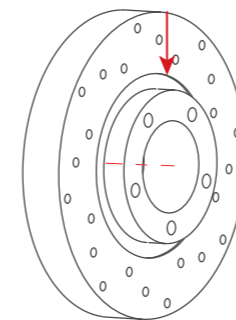

精车刹车盘

finish turning brake flange

- 加工材质 work material: TL048A
- 刀片型号 insert type: 2MU-CNGA120408
- Vc=700m/min
- f=0.15mm/rev
- ap=0.3mm
- dry cut

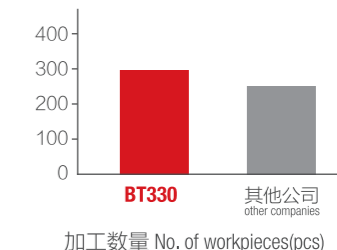

高温合金及烧结金属切削CBN系列

CBN series for cutting high temperature alloy and sintering metal



◆ 特点:

山田非涂层 CBN 高温合金及烧结金属切削系列, 选用特殊的结合剂和 CBN 微粒烧结而成, 具有很高的强韧性, 在刀尖很锋利的情况下依然可以保持刀口具有很高的强度, 从而可以抑制高温合金切削时毛刺的产生, 并实现稳定加工。

◆ Feature:

Yamada uncoated CBN high temperature alloy and sintering metal series, adopts special binder and CBN particles sintered, has strong toughness, and keeps cutting edge with a high strength in sharp tool nose, so it can prevent the burrs to generate in cutting high temperature alloy, and achieve the machining stability.

淬火钢加工推荐切削条件

recommended cutting condition for machining hardened steel

材质 material	切削速度 cutting speed Vc(m/min)						进给 feed rate f (mm/rev)	切深 depth of cut ap (mm)
	50	100	150	200	250	300		
BT510	50-90-150						0.03-0.08-0.15	0.05-0.15-0.25
BT520	50-150-220						0.05-0.12-0.25	0.1-0.3-0.5

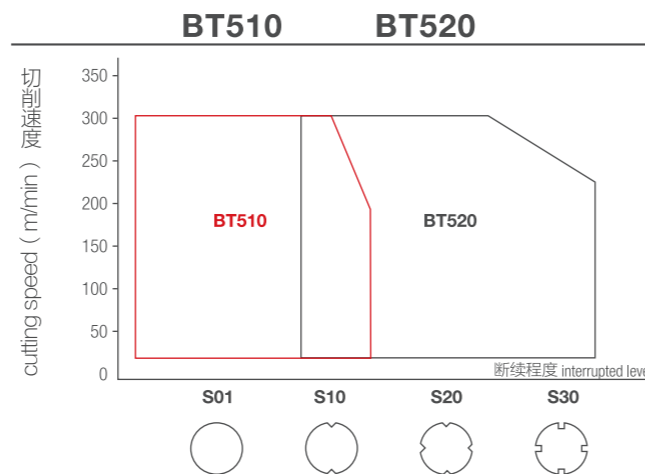

加工实例

Process instance

BT510 连续 - 轻断续 continuous-light interrupted

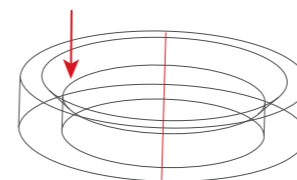

进气阀座精加工

intake valve seat finish machining

- 加工材质 work material: 粉末冶金 powder metallurgy
- 刀片型号 insert type: HDGN060200
- Vc=95m/min
- fz=0.08mm/rev
- ap=0.2mm
- wet cut

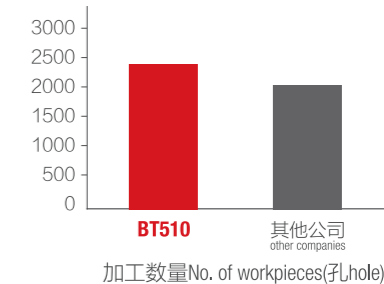

BT520 连续 - 断续 continuous-interrupted

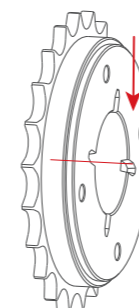

精加工端面

finish machining end face

- 加工材质 work material: 高温合金 high temperature alloy
- 刀片型号 insert type: 2MU-CNGA120408
- Vc=180m/min
- f=0.12mm/rev
- ap=0.25mm
- wet cut

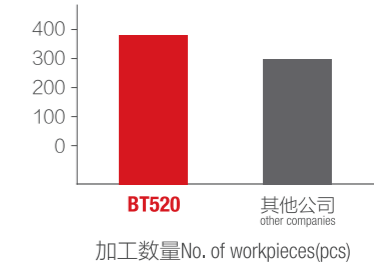

CBN断屑槽系列

CBN chipbreaker series

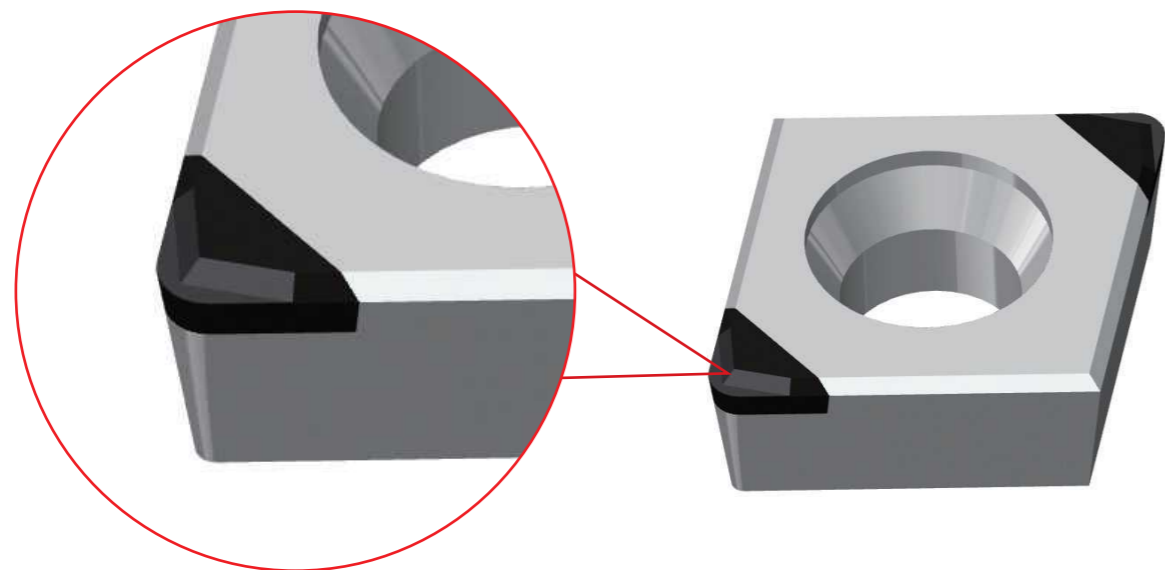

◆ 特点:

山田专利的断屑槽系列,可以分别应用在不同加工工况和不同加工余量的切削中。在折断铁屑的同时,保证更长的刀具寿命。

◆ Feature:

Yamada patented chipbreaker series,can be applied to cutting in similar working condition and different working allowance.Longer tool life is ensured while breaking iron scrap.

加工案例 process case



- 齿圈内孔粗加工**
gear ring inner hole rough machining
- 加工材质work material: 20CrMnTi
 - 刀片型号insert type: 2MC-CCGT09T304
 - $V_c=160\text{m/min}$
 - $f=0.15\text{mm/rev}$
 - $ap=0.75\text{mm}$

断屑效果 chip breaking result



无断屑槽 without chipbreaker



TR型断屑槽 TR type chipbreaker

CBN修光刃系列

CBN wiper series

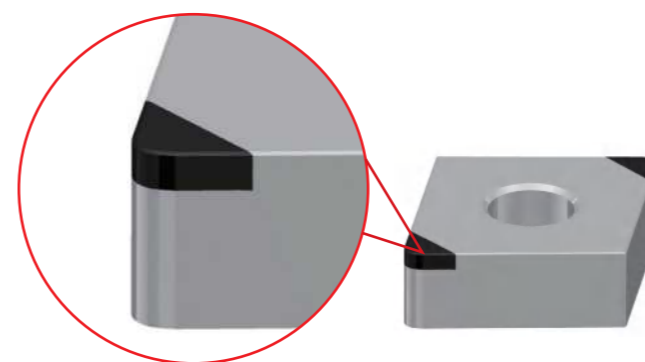

◆ 特点:

山田 CBN 修光刃系列,进一步巩固了以车代磨的加工技术,在低线速和高进给的切削环境下取得更加优异的表面粗糙度,可以与磨削相抗衡,具有高效率、高寿命和优异的光洁度!

◆ Feature:

Yamada CBN wiper series,reinforces the technology of turning instead of grinding,enabling more excellent surface roughness equal to grinding processing,with high efficiency,long life and outstanding roughness.

修光刃刀片切削方式 wiper insert cutting method

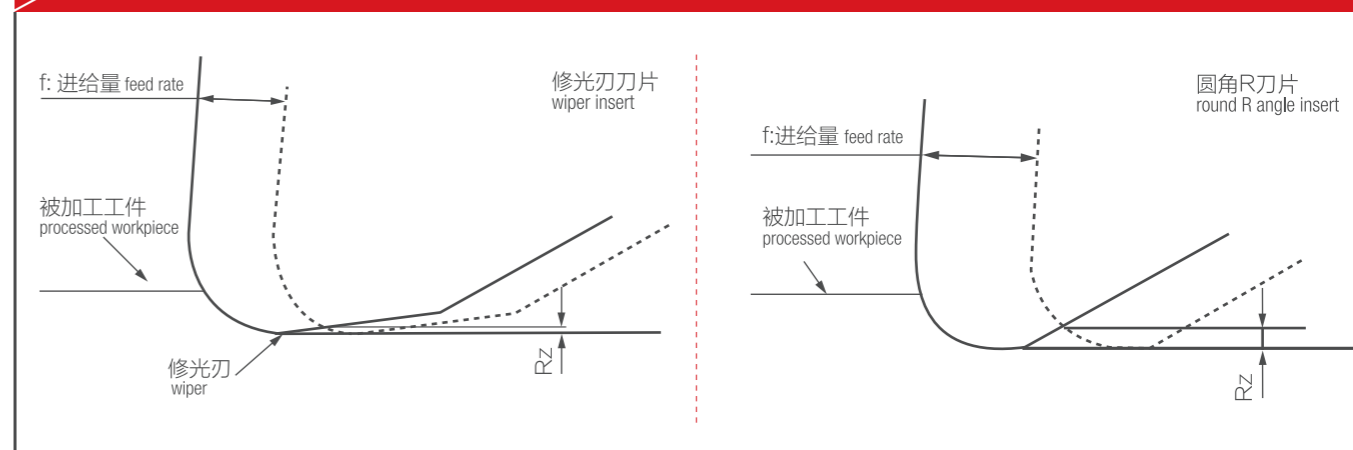

修光刃刀片使用性能 wiper insert use performance

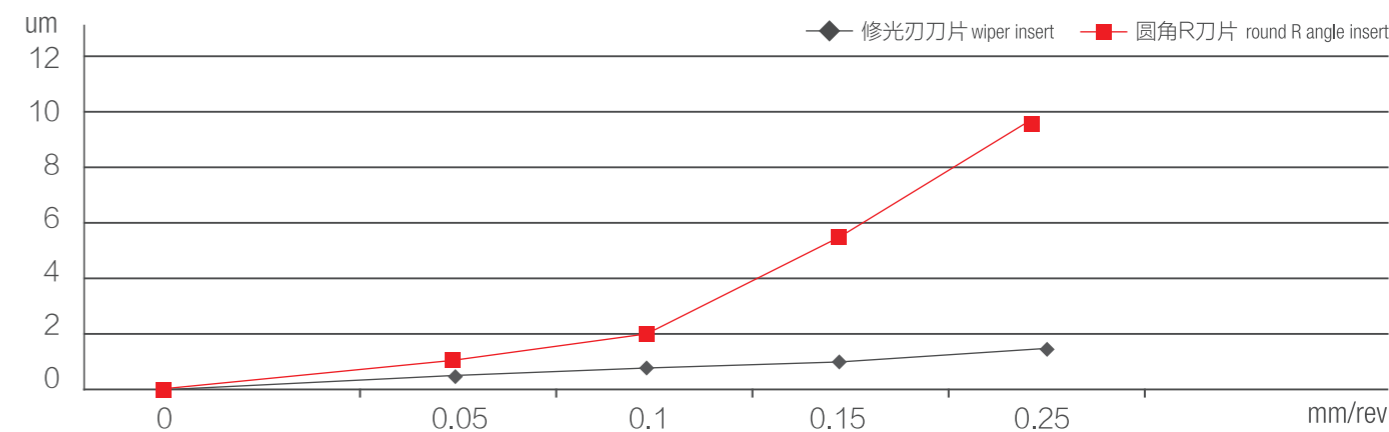

外观 Appearance	刀尖形状 Edge Shape	刃数 No. of edges	型号 Type	材质 Material											内切圆 (C d) Inscribed circle	厚度 (s) Thickness	刀尖r角 Nose Radius	孔径 (C d1) Hole Diameter	
				BT10	BT20	BT30	BT100	BT110	BT120	BT130	BT135	BT310	BT320	BT330					BT510
	锋利型 sharp type	3	TNGA	160404SH	•											9.525	4.76	0.4	3.81
				160408SH	•													0.8	
				160412SH	•													1.2	
	断屑槽型 chipbreaker type	3	TNGG	160404TR												9.525	4.76	0.4	3.81
				160408TR	•										0.8				
				160412TR											1.2				
	标准型 standard type	3	TPGW	160404											6.35	3.18	0.4	4.4	
				160408													0.8		
		3	TPGW	110302											6.35	3.18	0.2	3.4	
				110304													0.4		
	锋利型 sharp type	3	TPGW	160404SH											9.525	4.76	0.4	4.4	
				160408SH													0.8		
3		TPGW	110302SH											6.35	3.18	0.2	3.4		
			110304SH													0.4			
			110308SH													0.8			
标准型 standard type	2	SNGA	120404											12.7	4.76	0.4	5.16		
			120408													0.8			
			120416													1.6			
	2	SNGA	120404SH											12.7	4.76	0.4	5.16		
			120408SH													0.8			
			120416SH													1.6			
	2	SCGW	09T304											9.525	3.97	0.4	4.4		
			09T308													0.8			
			09T312													1.2			
	4	SNGA	120404											12.7	4.76	0.4	5.16		
120408													0.8						
120416													1.6						
4	SCGW	09T304											9.525	3.97	0.4	4.4			
		09T308													0.8				
		09T312													1.2				

外观 Appearance	刀尖形状 Edge Shape	刃数 No. of edges	型号 Type	材质 Material											内切圆 (C d) Inscribed circle	厚度 (s) Thickness	刀尖r角 Nose Radius	孔径 (C d1) Hole Diameter		
				BT10	BT20	BT30	BT100	BT110	BT120	BT130	BT135	BT310	BT320	BT330					BT510	BT520
	标准型 standard type	3	WNGA	080404											12.7	4.76	0.4	5.16		
				080408													0.8			
				080412															1.2	
	标准型 standard type		RNGN	120700FU										12	7.94					
				090600FU														9	6.35	
		3	TBGN	060102FU										3.97	1.59	0.2				
				060104FU														0.4		
				060108FU															0.8	
		4	SDGN	060201FU										6.35	2.38	0.1				
		6	HDGN	060200FU											6	2.5				
				BNGNT0200L R/L											25	2.0	0.2	4		
				BNGNT0250L R/L												25	2.5	0.2	4	
				BNGNT0302L R/L													25	3.0	0.4	5
				BNGNT0400L R/L													26	4.0	0.4	6
				BNGNT0450L R/L													26	4.5	0.4	6
				BNGNT0500L R/L													26	5.0	0.4	6
				BNGNT0600L R/L													27	6.0	0.4	7
				GBA40R/L150											11.7	1.5	0.2	3.5		
				GBA40R/L175												11.7	1.75		0.2	
				GBA40R/L200													11.7	2.0	0.2	4.0
				GBA40R/L230													11.7	2.3	0.2	
				GBA40R/L250													11.7	2.5	0.3	
				GBA40R/L280													11.7	2.8	0.3	
				GBA40R/L300													11.7	3.0	0.3	

各品牌材质对照表

Brand grades comparison listing

工件材质 work material	加工类型 process form	山田 YAMADA	住友 SUMITOMO	京瓷 KYOCERA	克劳伊(大因) KORLOY(DINE)	三菱 MITSUBISHI	山特维克 SANDVIK	山高 SECO	伊斯卡 ISCAR	泰珂洛(东芝) TUNGALOY	特固克 TAEGUTEK	肯纳 KENNAMETAL
H 淬硬钢 Hard Materials	H01	BTC10	BNC100	KBN05M	KB410	BC8105	CB7105	CBN10	IB50	BXM10		KB5610
		BT100	BNC2010	KBN10M	KB1000	BC8110	CB7115	CBN100	IB10H	BX310		
			BN1000	KBN510		MBC010		CBN060K	IB10HC			
			BN2000			MB810						
			BNX10									
	H10	BTC20	BNC160	KBN25M	DNC250	BC8110	CB7115	CBN10	IB20H	BXM10	KB90A	KBH20
		BT110	BNC200	KBN525	KB320	BC8120	CB20	CBN100	IB10H	BX330	TB650	KB5610
		BT120	BNC2010		KB2000	MBC020		CBN150	IB25HC			KB5625
			BNC2020			MB8025			IB25HA			
			BN2000			MB825						
	H20	BTC20	BNC200	KBN30M	KB420	BC8120	CB7025	CBN150	IB20H	BXA20		KBH20
		BT120	BNC2020	KBN35M	KB425	BC8020	CB50	CBN160C	IB55	BXM20		KB5625
		BT130	BNX20	KBN900	DNC350	MBC020			IB25HA	BX360		KB5630
						MB8025			IB25HC			
	H30	BTC30	BNC300	KBN900	KB335	BC8130	CB7525		IB90	BXM20		KB5630
BT130		BN7000			MB835				BXC50			
BT135		BN7500							BX380			
K 铸铁 Cast Iron	K01	BT310	BN700	KBN60M	KB350	MB710	CB50	CBN200	IB90	BX910	KB90	KB1340
			BNC500	KBN65B		MB5015	CB7525	CBN300		BX930		
										BX870		
	K10	BT310	BN7000	KBN60M	KB370	MB710	CB7925	CBN300P	IB90	BX470	KB90A	
		BT320	BN7500	KBN900		MB5015		CBN400C	IB90A	BX480		
			BNS800	KBN65B		MB4020				BX950		
	K20	BT320	BN7000	KBN900	KB800	MB730		CBN200	IB90A	BX470	KB90A	
		BT330	BNS800			MB4020		CBN300		BX480		
						MBS140				BX950		
	K30	BT320	BN7500	KBN900		MBS140		CBN500		BXC90		KB5630
BT330		BNS800							BX90S			
S 耐热合金 Super alloys Sintered Metals	S01	BT510	BN7000	KBN65M	KB370	MB730			IB05S	BX940		KB5630
	S10	BT520	BN7500	KBN70M	KB370	MB4020			IB10S	BX950		KB1340
										BX470		
									BX480			